

# SAGINAW CONTROL & ENGINEERING SCE-60XEL4924LP

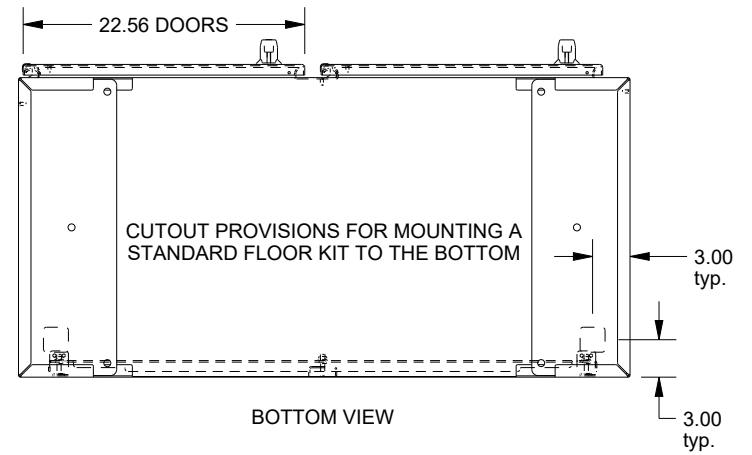
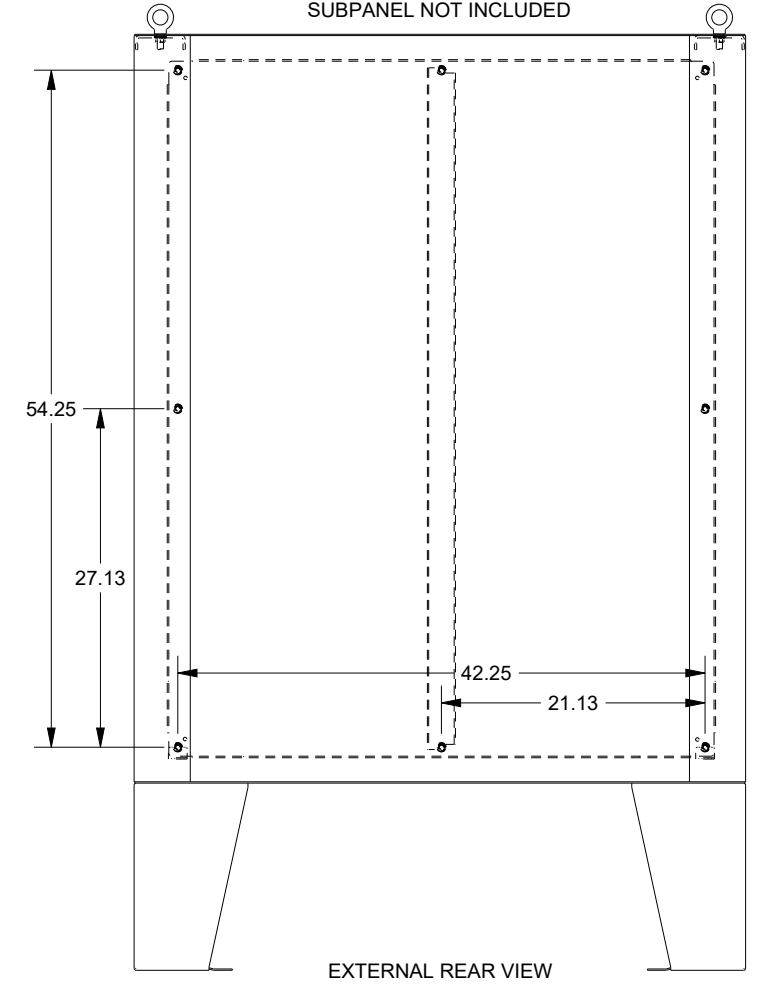
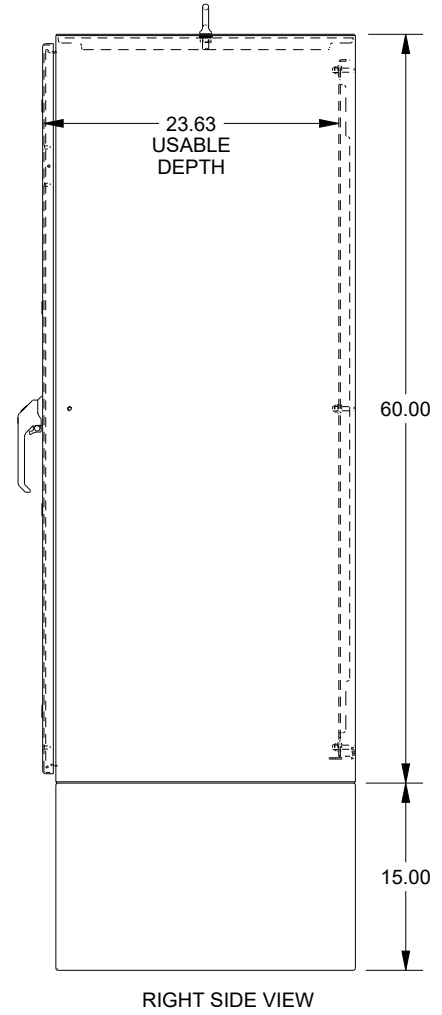
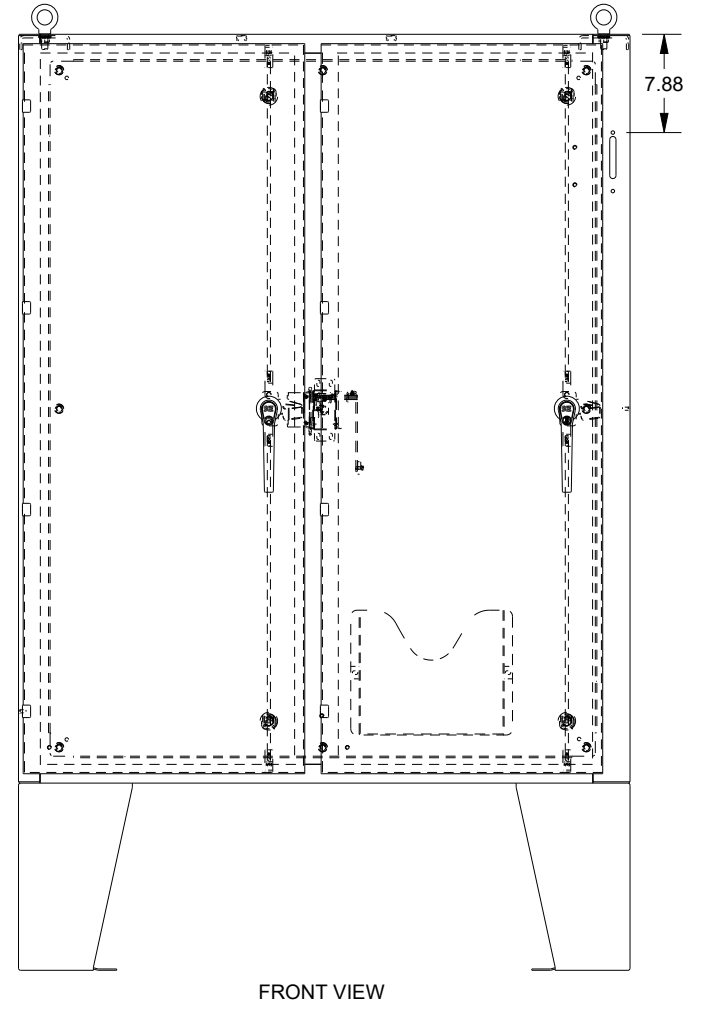
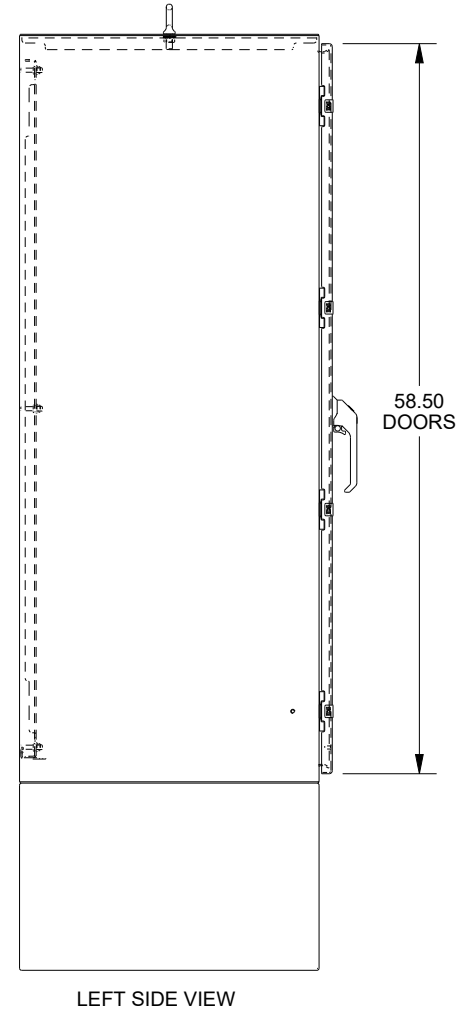
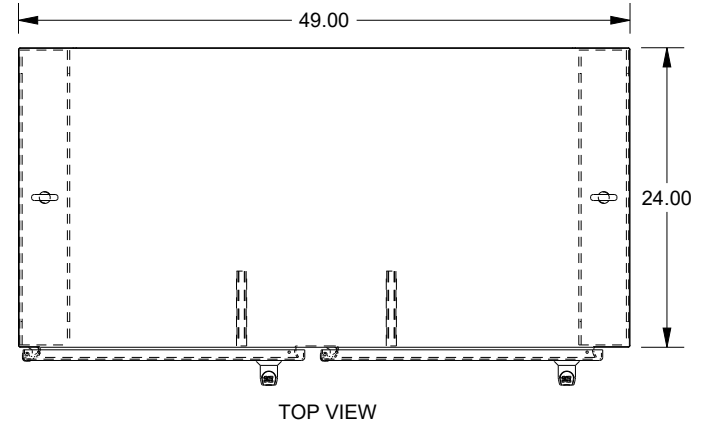

WASH SYSTEM 2" SQUARE DRAIN HOLES IN THE  
BOTTOM WITH UL APPROVED HOLE SEALS PROVIDED